



**Not Just  
Replacements...**

---

**But Improvements**



**The ZOT Solutions** line of parts and assemblies have been at the core of the company's line since it was founded more than five decades ago. These products provide improvements to the original manufacturers design as unique problem-solving products that offer a quick repair during a crisis breakdown and, at the same time, provide a permanent solution.

## Design Features

For the most part, the Solutions line is designed to keep your machines running in tip top condition. As an example, the Deck Right Deck Saver will permanently resolve crowned decks while the, often imitated, ZOT Three Piece Modular Rake Shaft Assembly features reinforcements at potential breakpoints that are not included on the original manufacturers' product, or any other aftermarket brand. The ZOT product will outlast other brands by years and even decades.



## Safety in the Workplace

The line includes safety products like Steel Steps that mount on the rear of 82-70 and 82-90 Pinspotters. And a Catwalk Handle for A, A2 and Jetback Pinsetters, which makes climbing onto the machine easier and therefore safer. And, many centers no longer have an electrical box cover, which has been removed to enable access to the electronics and never replaced. ZOT's Electrical Box Cover features a latched panel which drops down for easy access and provides a place to rest tools while the mechanic works on the electronics.



## Repair Kits

ZOT offers several unique problem-solving repair kits, all of which are bolt-on solutions as opposed to, in some instances, requiring hazardous on or off the machine welding. There are eight such repair kits in the catalog including for the Deck Shield, Wheel Guard Bracket, Shaker Pulley Arm, Rake Return Pivot, Wishbone and Tri-Plate Bushing.



## Cost Benefits

Having a product like the Rake Arm Repair Kit, will have a Pinsetter back up and running in just minutes, whereas Tiger Grip Strips, Accelerator Support Kit and the Power Ball Spin Eliminator will ensure bowling balls are returned to the bowler without hinderance or delay, thereby not slowing down the pace of bowling. These all add to customer satisfaction and a reduce loss of revenue during down times.



## ZOT Parts for 'A', 'A2' & Jetback Pinsetters

### Accelerator Support Kit

**Z420206** For A2 Pinsetters. Maintains Proper Belt Tracking



### Deck Shield Repair Kit

**Z420038** For A, A2 & Jetback Pinsetters

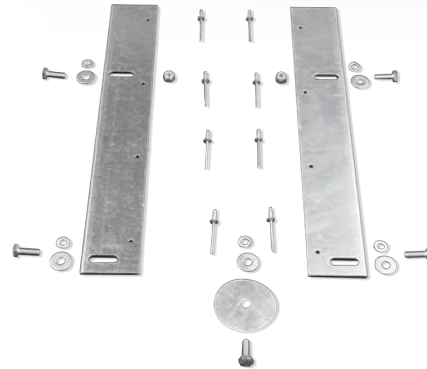

### 'Y' Switch Stop Conversion Kit

**Z420072** For A2 & Jetback Pinsetters.



### Clutch Yoke Screw Conversion

**Z420034** For A, A2 & Jetback Pinsetters

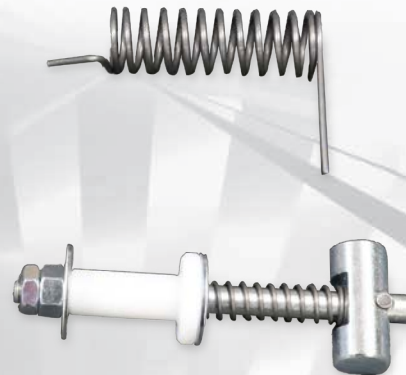

### 'Y' Track Ball Deflector Kit

**Z420284** For 'A' Pinsetters and ZOT Mini Conversions



### Deck Lift Shaft Repair Kit

**Z420037** For A, A2 & Jetback Pinsetters

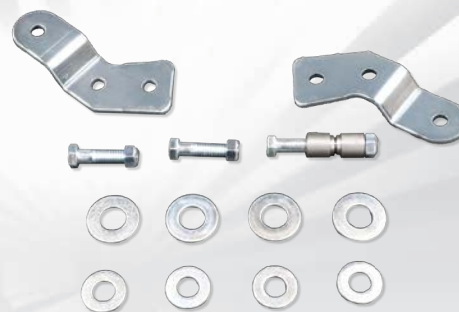

## ZOT Parts for 'A', 'A2' & Jetback Pinsetters

### Deck Right Deck Saver

**Z420084** For A, A2 & Jetback Pinsetters  
Eliminates Crown Decks



### Cam Follower Shaft Support Bracket

**Z420502** For A, A2 & Jetback Pinsetters



### Ball Lift Rod Spring Conversion Kit

**Z420036** For A, A2 & Jetback Pinsetters and  
ZOT Conversion



### Return Track Mounting Bridge Kit

**Z420031** For 'A' Pinsetters,  
Mini Jetback &  
ZOT I Conversions

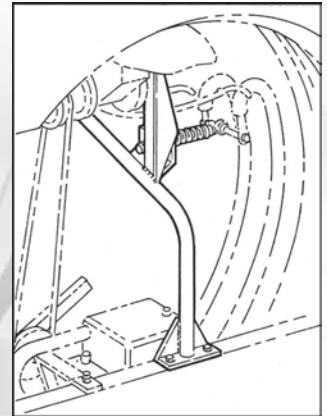

### Adjustable Ball Lift Rod Clamp

**Z420050** For A, A2 & Jetback Pinsetters



### Pin Retainer Kit

**Z420180** For A, A2 & Jetback Pinsetters  
Retains pins in worn pinwheels



## ZOT Parts for 'A', 'A2' & Jetback Pinsetters

### Tiger Grip Strips

**Z420403** For all Pinsetter Ball Wheels  
(Three Strips per kit)

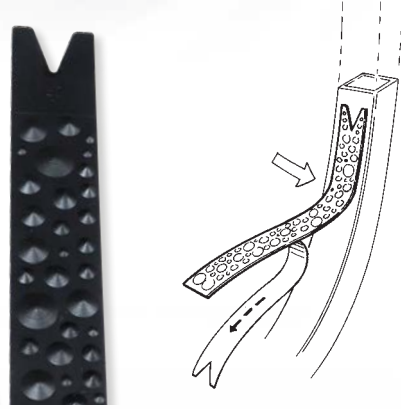

### Wheel Guard Bracket Repair Kit

**Z420086** 7-pin Side  
**Z420087** 10-pin Side



### Ball Lift Rod Stud Modification Kit

**Z420205** For A, A2 & Jetback Pinsetters

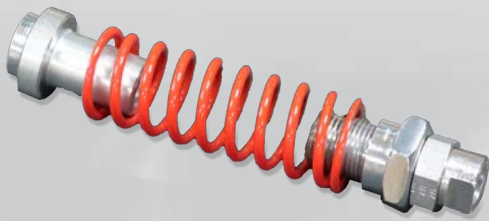

### Shaker Pulley Arm Pivot Repair

**Z420329** For A, A2 & Jetback Pinsetters

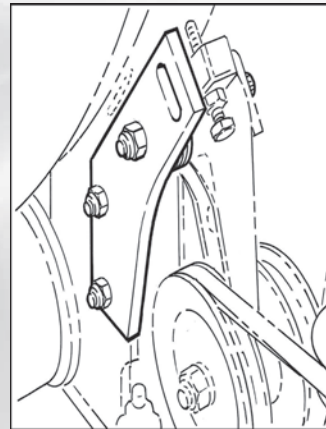

### Ball Damage Deflector

**Z420204** For A, A2 & Jetback Pinsetters  
For odd numbered Lanes rear ball tracks

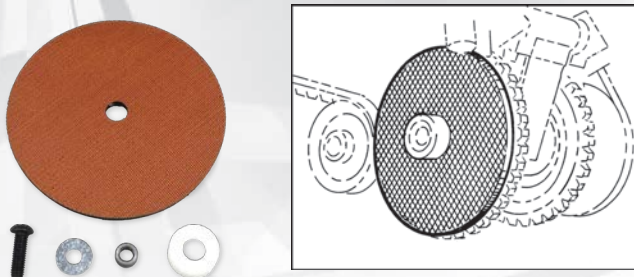

### Spring Eyelet Repair Kit (Turret Release)

**Z420178** For A, A2 & Jetback Pinsetters



## ZOT Parts for 'A', 'A2' & Jetback Pinsetters

### Power Ball Spin Eliminator Kit

**Z420179** For A, A2 & Jetback Pinsetters

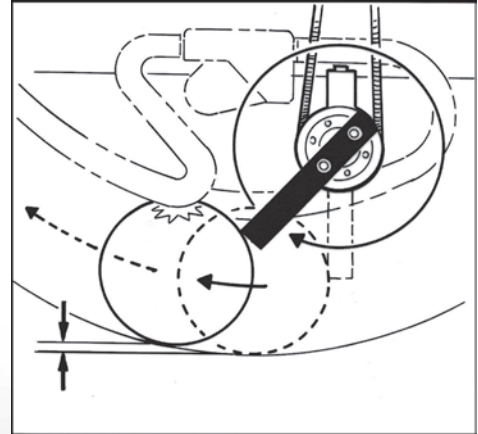

### Three Piece Modular Rake Shaft Assembly

**Z420150** For A, A2 & Jetback Pinsetters



### Replacement Pit Cushion Arms

For 'A' Pinsetters

**Z420006** (7-pin side)

**Z420005** (10-pin side)



## ZOT Parts for 'A', 'A2' & Jetback Pinsetters

### Rake Tube Conversion

For A, A2 & Jetback Pinsetters

- |                              |                              |
|------------------------------|------------------------------|
| <b>Z420068</b> (7-pin side)  | <b>Z420082</b> (7-pin side)  |
| <b>Z420069</b> (10-pin side) | <b>Z420083</b> (10-pin side) |
| (for Grey Machines)          | (for Green Machines)         |



### Rake Lift Arm 'V' Lever Repair Kit

**Z420071** For A, A2 & Jetback Pinsetters



### Pop Top Electrical Box Cover

**Z420186** For American made Pinsetters  
**Z420187** For Japanese made Pinsetters

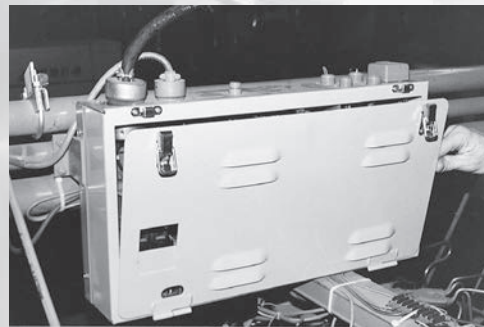

### Shock Mount Pivot Repair Kit

**Z420310** For A2 & Jetback Pinsetters



### Rake Arm Repair Kit

**Z420033** For A, A2 & Jetback Pinsetters



## ZOT Parts for 'A', 'A2' & Jetback Pinsetters

### Rake Lift Arm 'C' Lever Repair Kit

**Z420090** For A, A2 & Jetback Pinsetters



### Catwalk Handle

**Z420312** For A, A2 & Jetback Pinsetters



### Rake Return Pivot Repair

**Z420181** For A, A2 & Jetback Pinsetters



### Bolt-on Wishbone Brace Permanent Repair Kit

For A, A2 & Jetback Pinsetters

**Z420010** (7-pin side)  
**Z420011** (10-pin side)



### Adjustable Short Link

**Z420073** For A, A2 & Jetback Pinsetters





## ZOT Parts for 'A', 'A2' & Jetback Pinsetters

### Urethane Follow Link Roller

**Z810014** For A2 Cushion Linkage



### Tri-plate Bushing Kit

**Z420007** For 'A' Pinsetters  
Note: Kit does not include Tri-plate

**Z620019** – Order separately



### Carpet King

**Z420505** for A, A2 & Jetback Pinsetters  
(overlay for existing Pit Carpet)

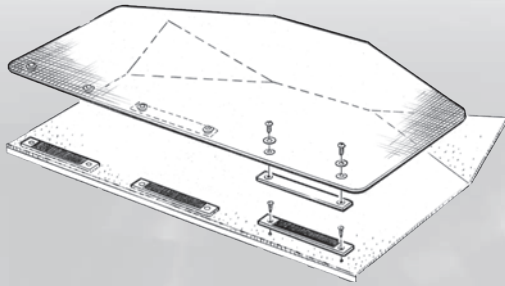

### Tri-plate

**Z620019** For 'A' Pinsetters



### Starter Bellcrank Stud

**Z420014** For A & Jetback Pinsetters



### Curtain Bracket Nut Plate Kit

**Z420020** For A & Jetback Pinsetters



## ZOT Parts for 82-30 & 82-70 Pinspotters & A, A2 & Jetback Pinsetters

### Enhanced Ball Return Assembly Pad Kit

**Z420402** For 82-30 & 82-70 Pinspotters with Kicker Style Ball Returns

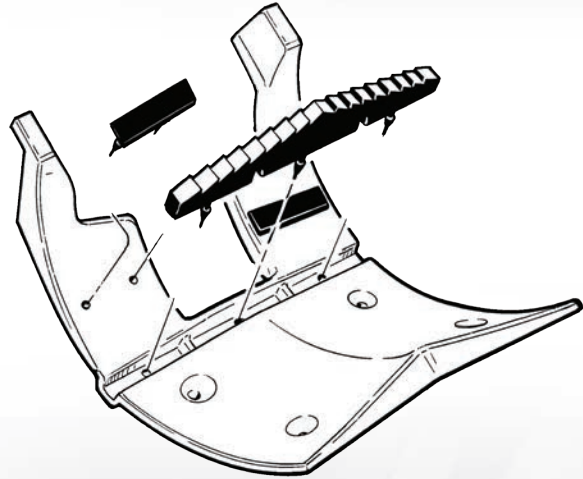
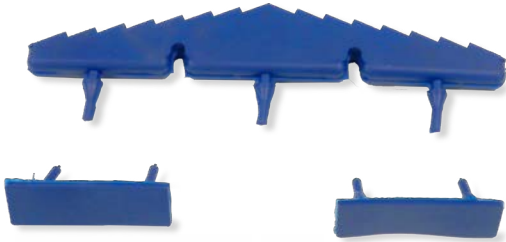

### Rear Mounted Steel Steps

**Z420286** For 82-30 Pinspotters

**Z420290** For 82-90 Pinspotters



## ZOT Parts for 82-30 & 82-70 Pinsetters & A, A2 & Jetback Pinsetters

### Link Belt

Permanent replacement for endless & spliced 'V' Belts for 82-30, 82-70, 82-90 Pinsetters & A, A2 & Jetback Pinsetters

**Z420189** (1/2" 20' per box)

**Z420190** (5/8" 20' per box)



### PermaDeck Kick Back Plates

**Z420484** 16" x 40"

For Pinsetters with Synthetic HPL Pindecks



**Z420482** 15" x 33"

For Pinsetters and Pinsetters

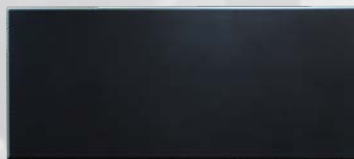

**Z420483** 19" x 23"

For early model Pinsetters



### Adjustable Bin Strap Kit

**Z420400** For 82-70 & 82-90 Pinsetters

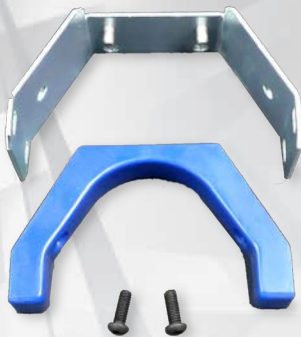

**Z420477** Bracket for 5-pin Spring



**Z420477** Pin Guide Plate





For more information contact your  
ZOT Bowling Parts Distributor  
or contact ZOT at:

Toll-free 1-877-236-8505  
Email: [sales@zotbowlingparts.com](mailto:sales@zotbowlingparts.com)  
Website: [www.zotbowlingparts.com](http://www.zotbowlingparts.com)